

CORTE A-A
ESCALA 5 : 1

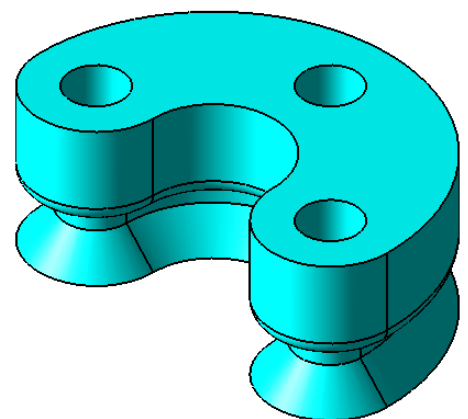

B 13-5

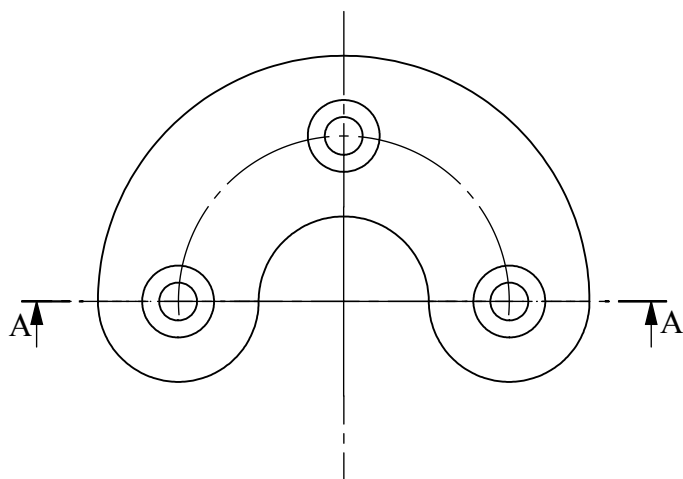
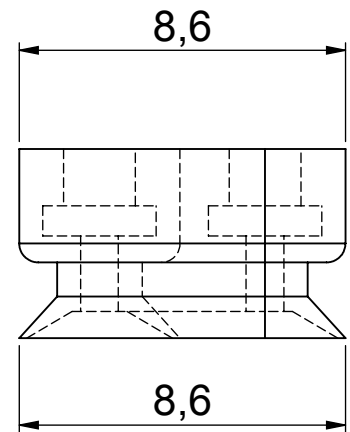
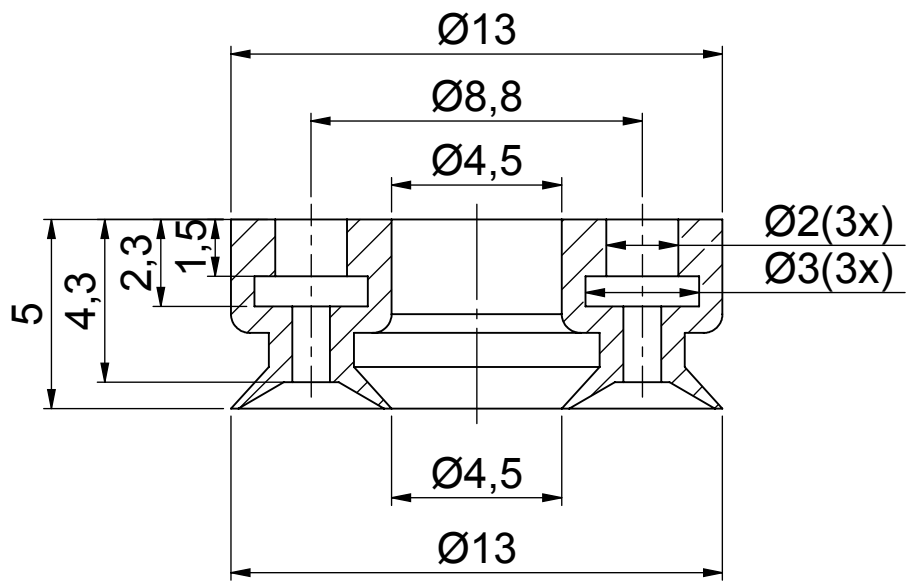