

CORTE A-A
ESCALA 4 : 1

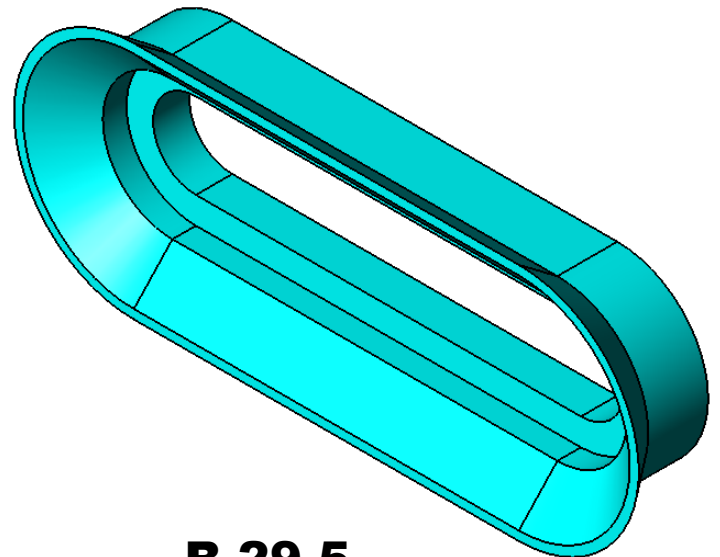
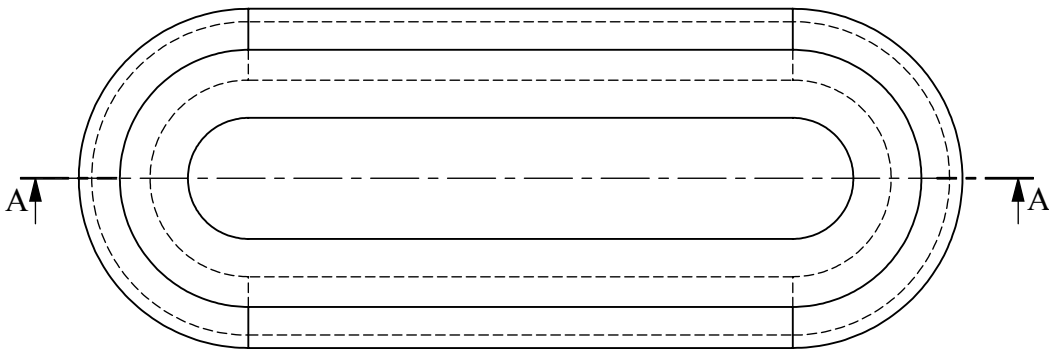
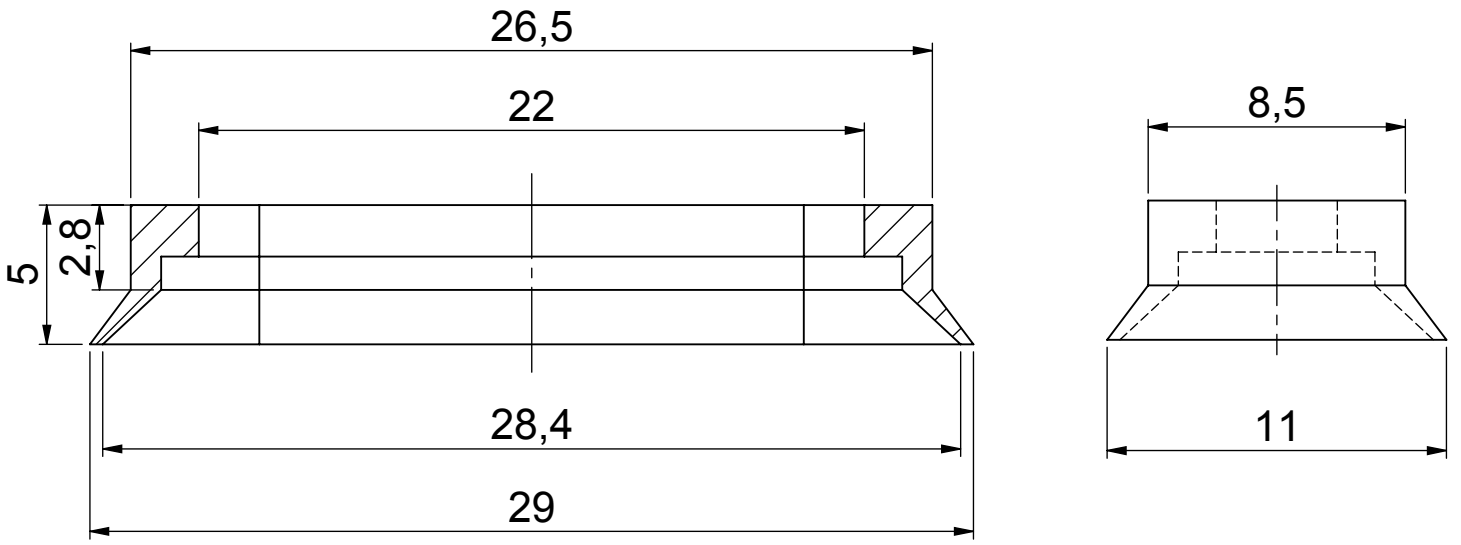

B 29-5