

CORTE A-A
ESCALA 2:1

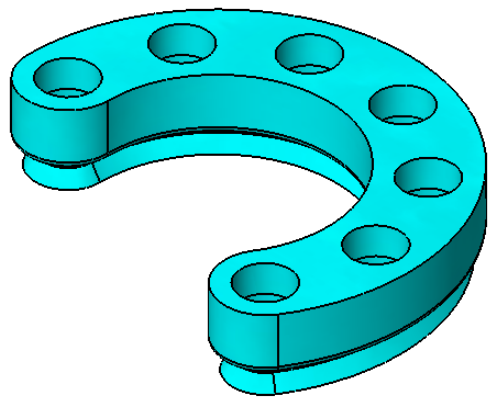

B 34-7

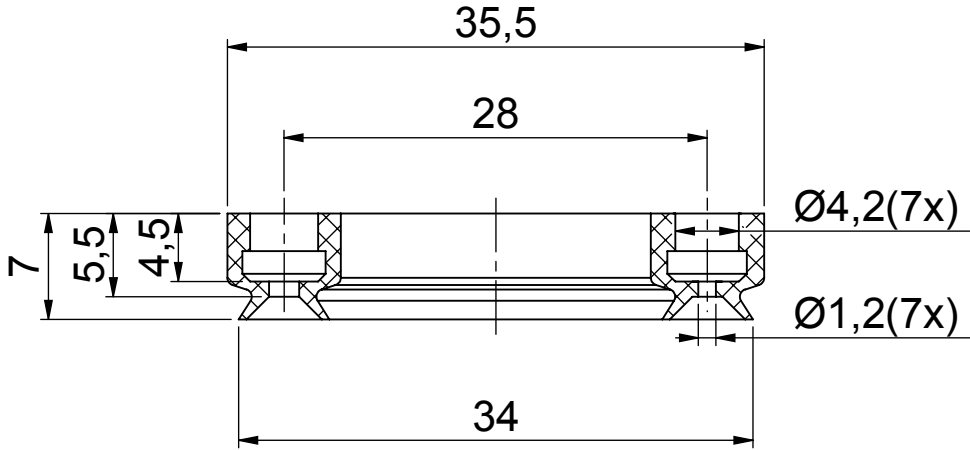