

CORTE A-A
ESCALA 3:1

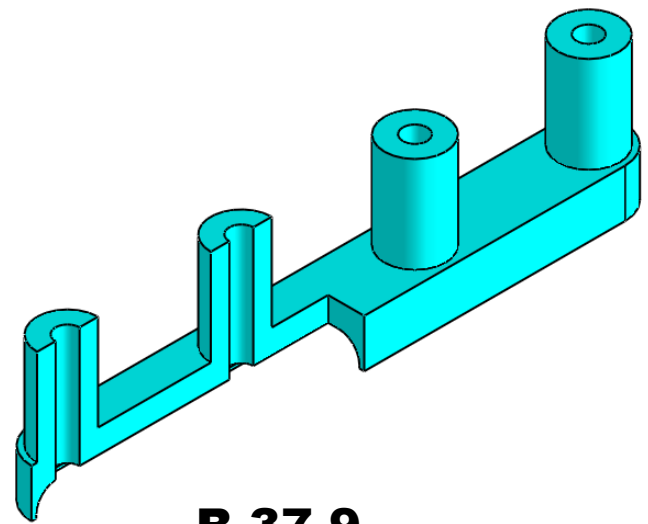

B 37-9

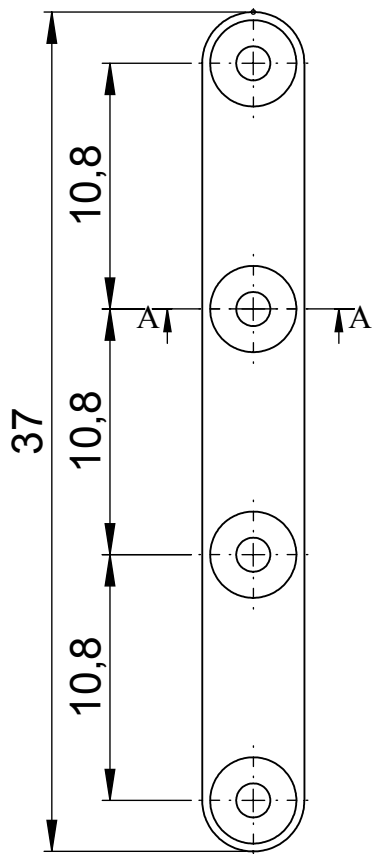