

CORTE A-A  
ESCALA 1:2

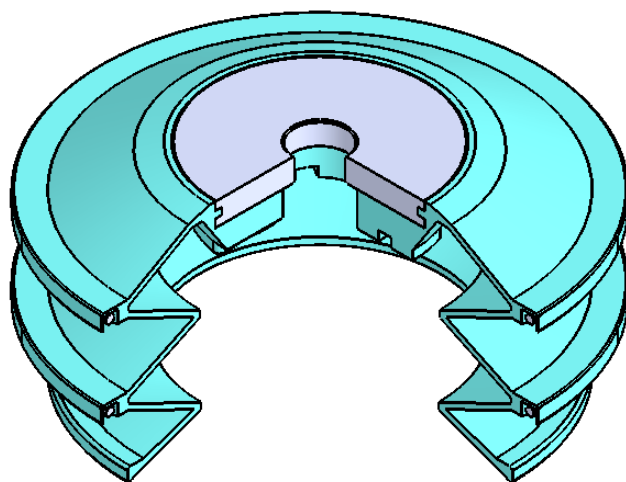

**D 145-75**

