

CORTE A-A
ESCALA 2:1

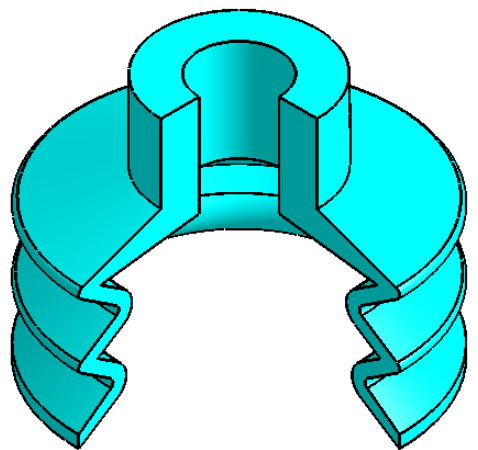

D 30-23

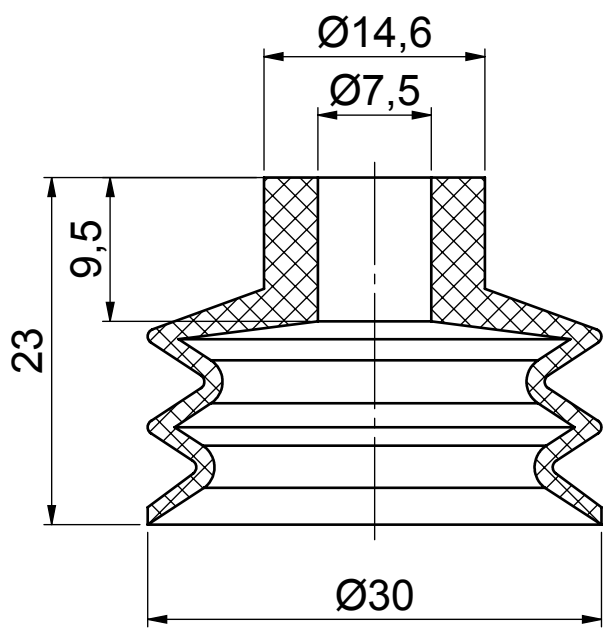