

CORTE A-A  
ESCALA 1:1.5

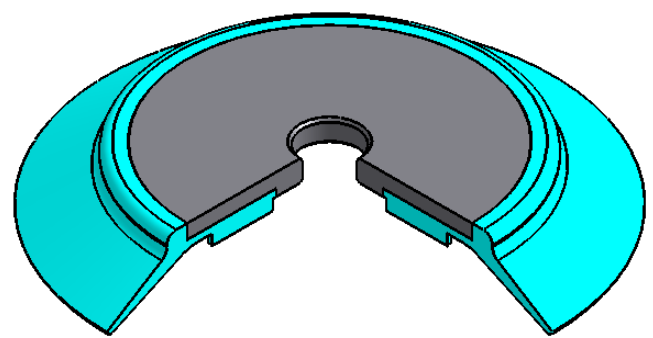

**F 125-16**

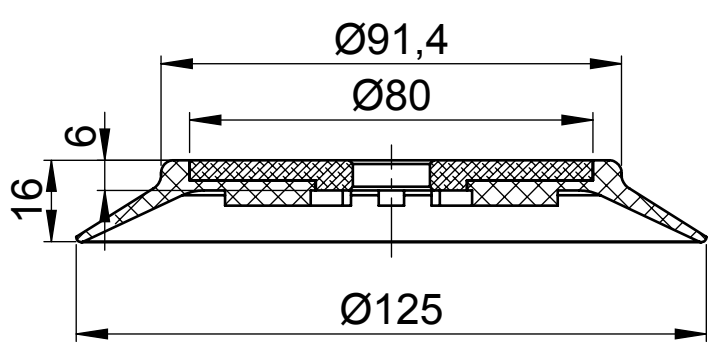