

CORTE A-A
ESCALA 1:2

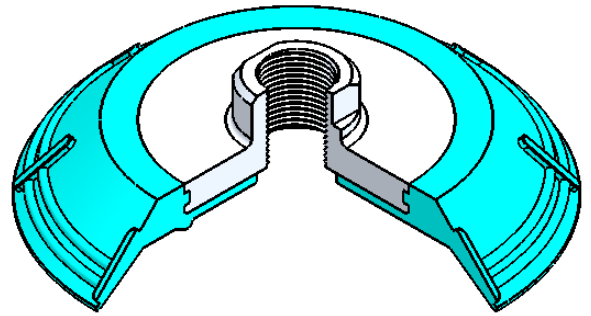

F 150-26

