

CORTE A-A
ESCALA 3.5:1

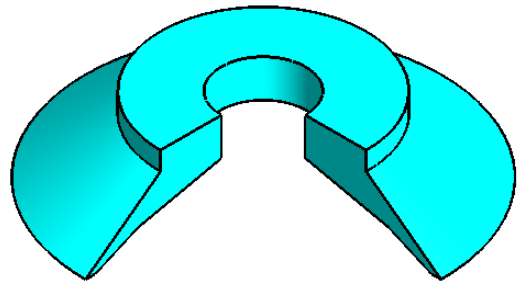

F 19-4

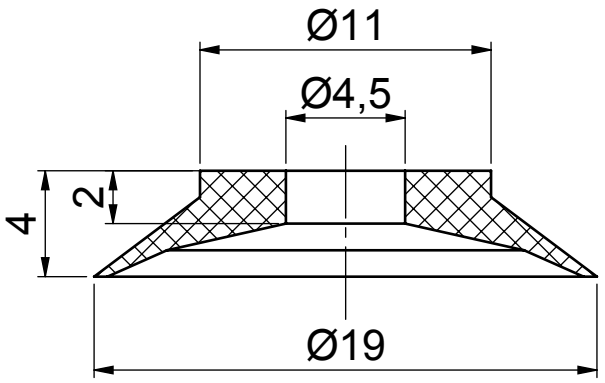