

CORTE A-A  
ESCALA 3:1

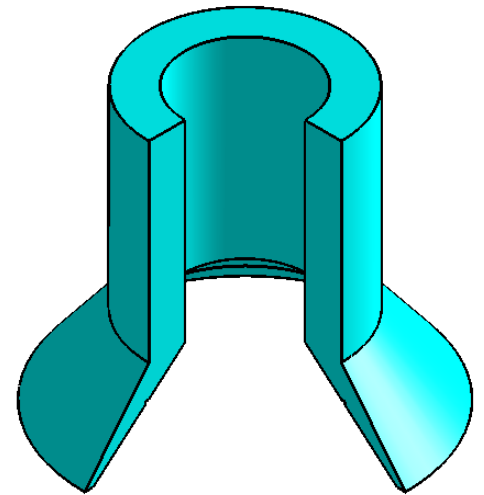

**F 20-17**

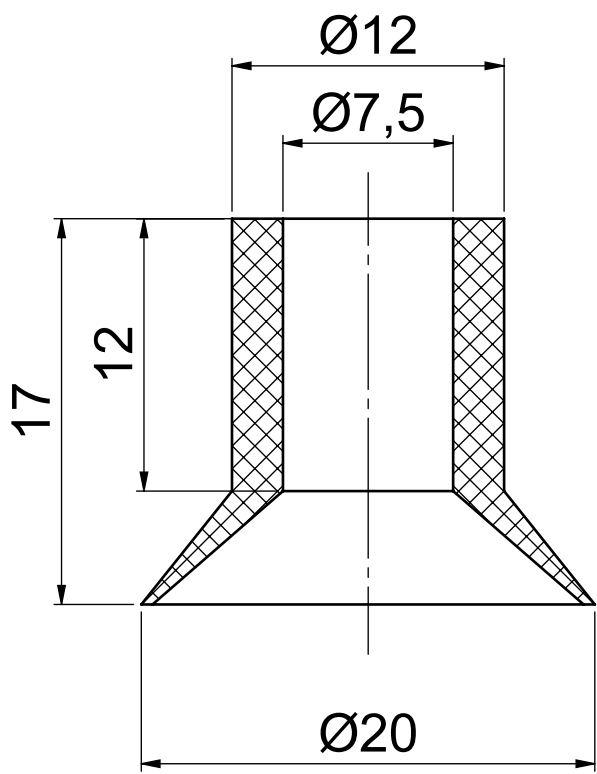