

CORTE A-A
ESCALA 3:1

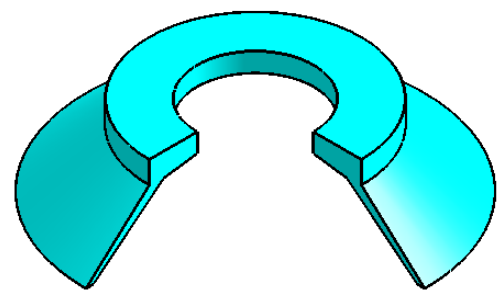

F 20-5

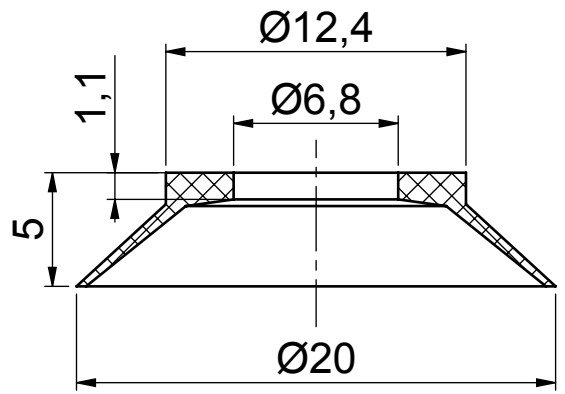