

CORTE A-A
ESCALA 3:1

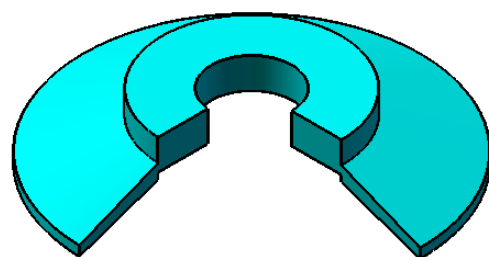

F 21-4

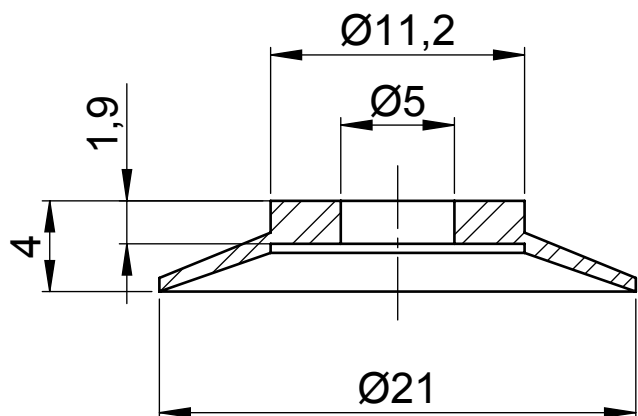