

CORTE A-A
ESCALA 3:1

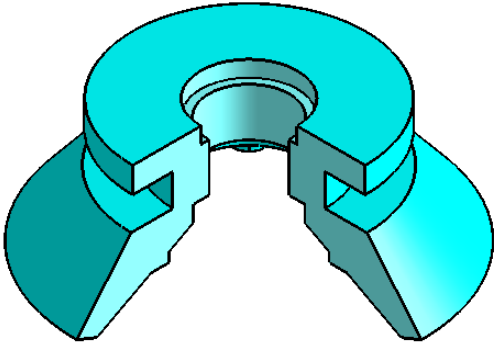

F 22-8

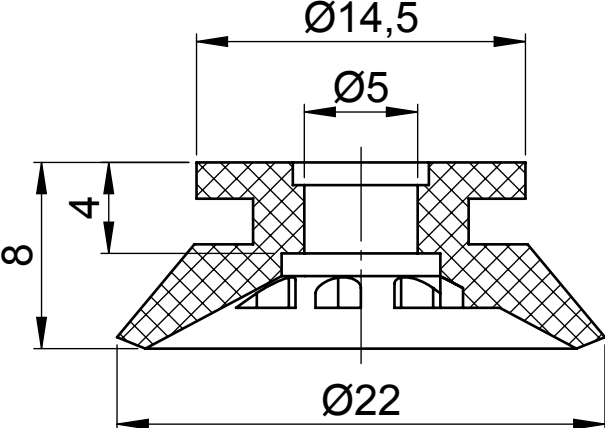