

CORTE A-A
ESCALA 1.5:1

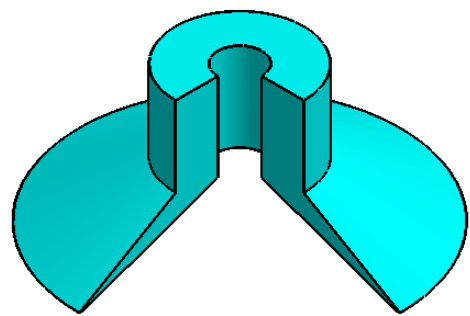

F 40-17

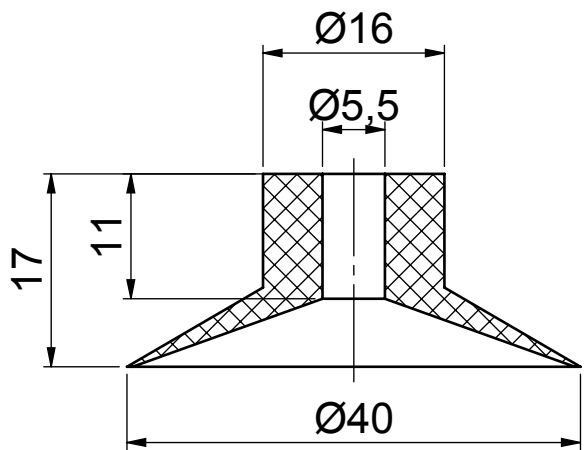