

CORTE A-A
ESCALA 1.6:1

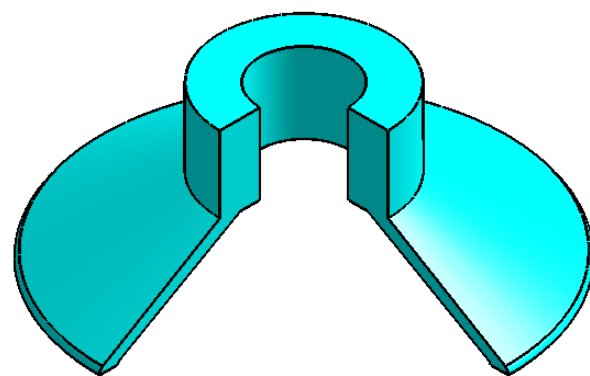

F 51-19

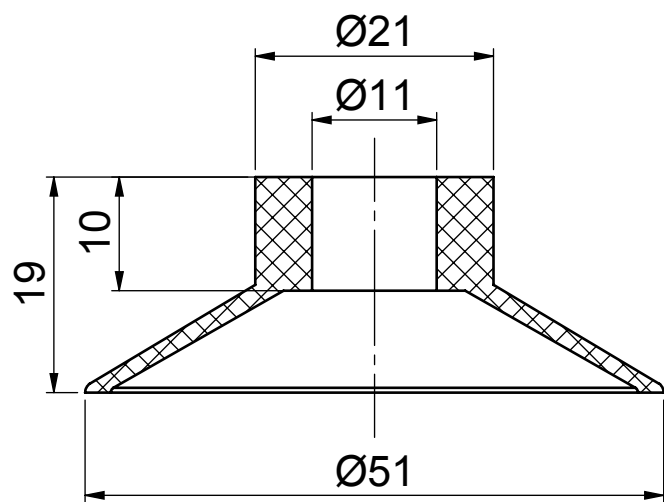