

CORTE A-A
ESCALA 2.7 : 1

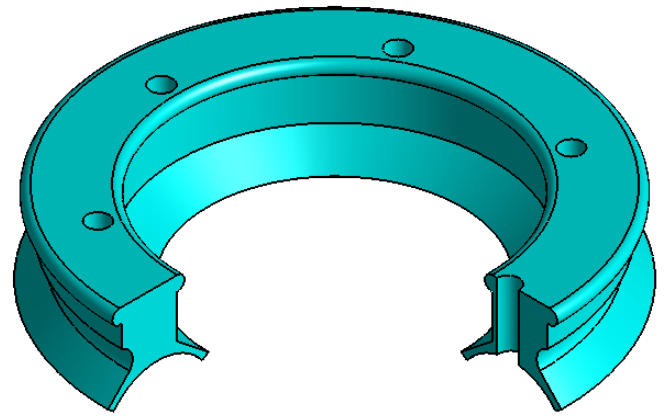

L32-6

