

CORTE A-A  
ESCALA 8:1

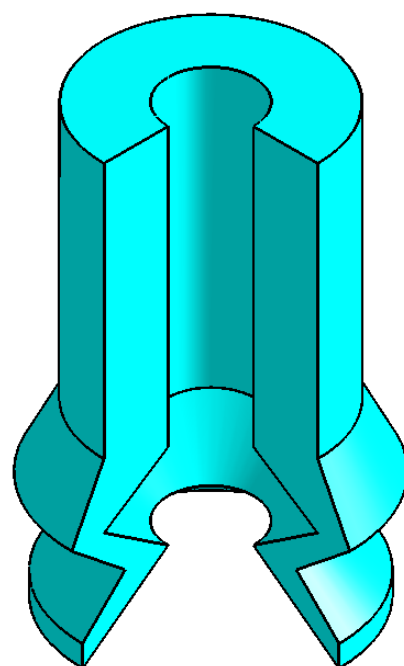

**S 6-10**

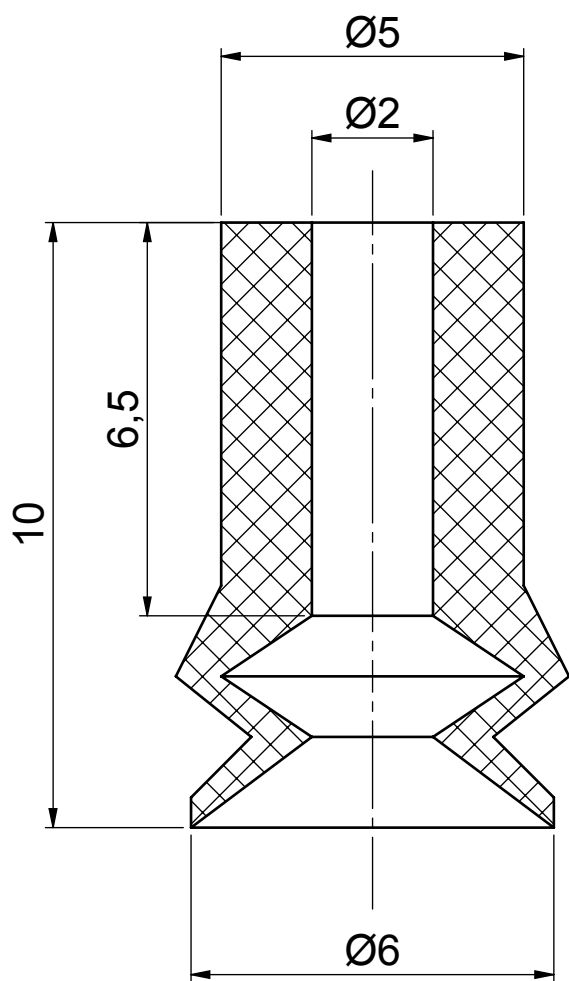