

CORTE A-A
ESCALA 3.5 : 1

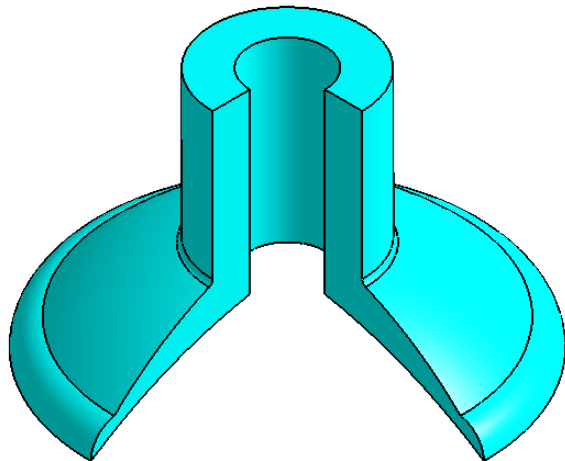

Y 21-13

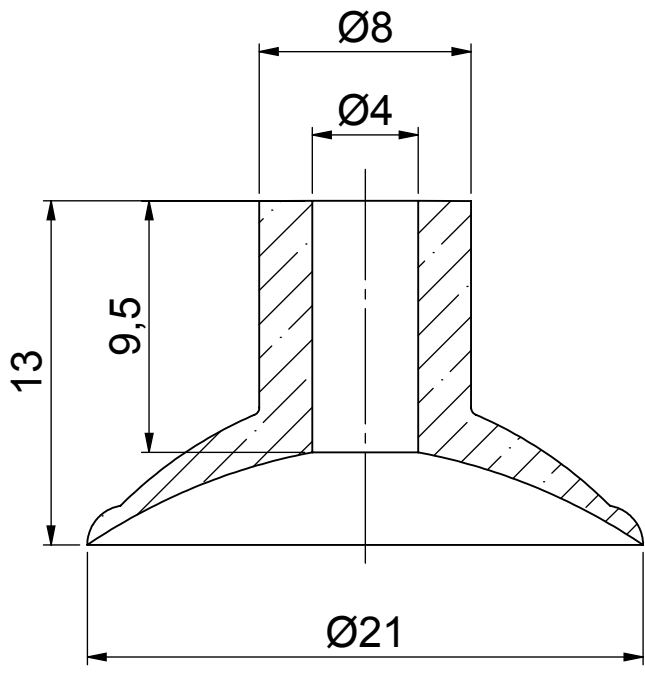