

CORTE A-A
ESCALA 3:1

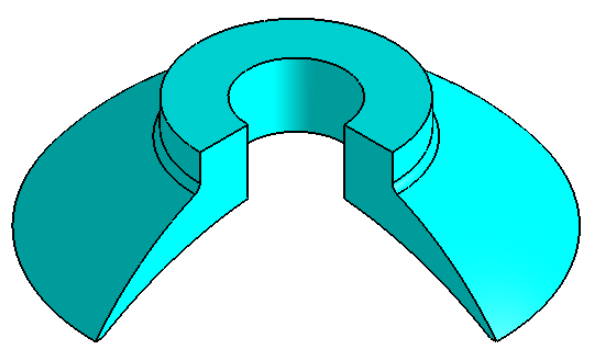

Y 25-7

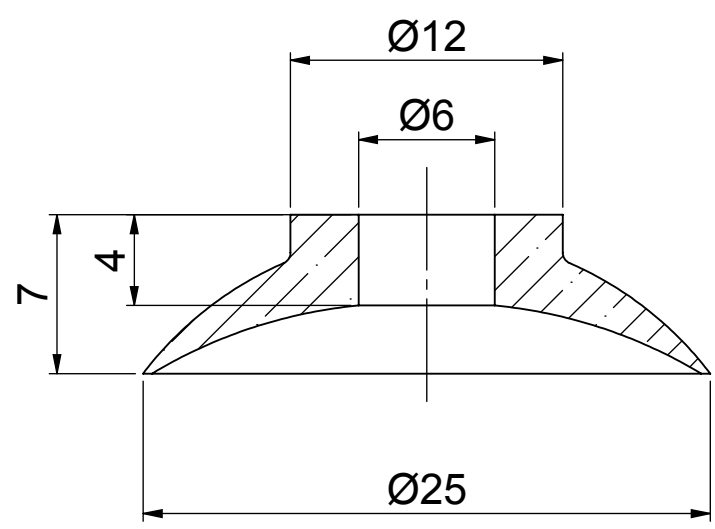