

CORTE A-A
ESCALA 2:1

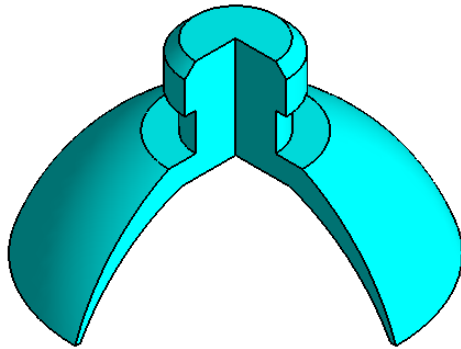

Y 30-18

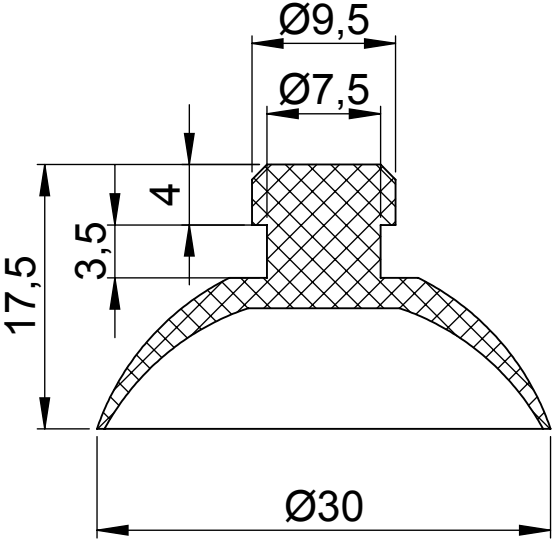